

Innovative, first-of-its-kind technology in architectural downlights, ELEMENT Reflections combines decorative recessed domes with beautifully controlled, reduced-glare indirect LED illumination. ELEMENT Reflections domes (available in 5", 8" and 12" diameters) are recessed into the ceiling plane and act as reflectors to a completely hidden ring of up-firing LEDs.

The Fleur dome transforms beautiful three-dimensional geometry for dramatic visual interest with the subtle play of light and shadow. All ELEMENT Reflections domes also offer two ceiling appearance options: flanged for a more traditional ceiling appearance; or flangeless for a smooth, mudded-in ceiling appearance.

### High quality LM80-tested LEDs

for consistent long-life performance and color

### Pristine design and illumination:

- Reduced glare, indirect illumination (dimnable for enhanced mood-setting options)
- Three Aperture Options: 5", 8" and 12"
- Beveled, rounded trim edges smoothly and seamlessly integrate into ceiling

### Housing and Trim/Dome sold separately.

## SPECIFICATIONS

DELIVERED LUMENS	5": 684 8": 943 12": 1989
WATTS	5": 9.2 8": 15 12": 30.8
VOLTAGE	Universal 120V-277V**
DIMMING	0-10V, ELV, TRIAC, Eco-system, Hi-Lume 2-Wire, Dali
LIGHT DISTRIBUTION	Lambertian
CCT	2700K, 3000K, 3500K, or Warm Color Dimming (3000K-2000K)
CRI	90+
CEILING APPEARANCE	Flanged (Trim accommodates a 1/2" to 1" ceiling thickness)
HOUSING	IC Airtight or Chicago Plenum
GENERAL LISTING	ETL, Damp listed, Title 24 (2700K, 3000K)
LED LIFETIME	L70; 50,000 Hours
WARRANTY*	5 Years



FLEUR  
shown in flanged

\*Visit ELEMENT-lighting.com for specific warranty limitations and details.

## ORDERING INFORMATION

HOUSING	SIZE	HOUSING RATING	DIMMABLE DRIVER	
EDIH	5R 5" DIAMETER	I IC AIRTIGHT	-ELD0	ELV/TRIAC/0-10V UNV* (LEAVE BLANK)
	8R 8" DIAMETER	C CHICAGO PLENUM	-ELD0A	ELDOLED 0.1% 0-0V LINEAR UNV*
	12R 12" DIAMETER		-ELD1	ELDOLED 0.1% 0-0V LOGARITHMIC UNV*
			-ELD1A	ELDOLED 1% 0-0V LINEAR UNV*
			-ELD1A	ELDOLED 1% 0-0V LOGARITHMIC UNV*
			-ELDD	ELDOLED 0.1% DALI UNV*
			-HLECO	HI-LUME ECO-SYSTEM FADE-TO-BLACK UNV*
			-HL2W	HI-LUME 2-WIRE**

MUST ORDER LED TRIM/DOME SEPARATELY.

\* UNV = 120V/277V INPUT VOLTAGE. \*\* HL2W 120V INPUT ONLY

TRIM/DOME	SIZE	CEILING APPEARANCE	CRI	CCT	DOME PATTERN	FINISH
EDIT	5R 5" DIAMETER	F FLANGED	9 90 CR	27 2700K	4 FLEUR	W WHITE
	8R 8" DIAMETER			30 3000K		
	12R 12" DIAMETER			35 3500K		
				WD 3000K-2000K WARM COLOR DIMMING		

# REFLECTIONS

## FLEUR FLANGED INDIRECT DOWNLIGHT

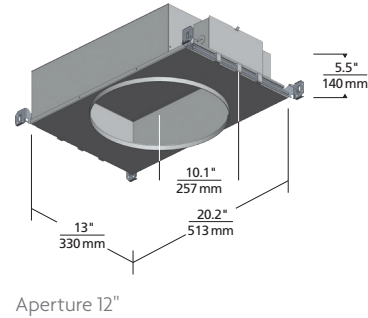
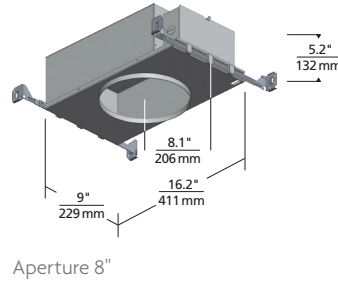
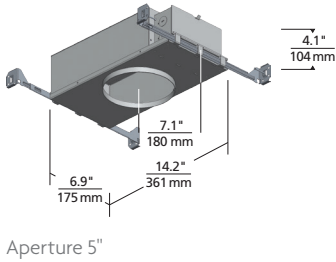
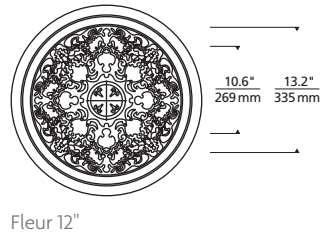
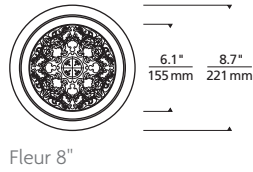
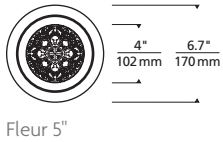

### PHOTOMETRICS\*

\*For latest photometrics, please visit [www.ELEMENT-Lighting.com](http://www.ELEMENT-Lighting.com)

#### FLEUR FLANGED 5"

Total Lumen Output:	684
Total Power:	9.2
Luminaire Efficacy:	74.1
Color Temp:	3000K
CRI:	90+

#### FLEUR FLANGED 8"

Total Lumen Output:	943
Total Power:	15
Luminaire Efficacy:	62.4
Color Temp:	3000K
CRI:	90+

#### FLEUR FLANGED 12"

Total Lumen Output:	1989
Total Power:	30.8
Luminaire Efficacy:	64.6
Color Temp:	3000K
CRI:	90+

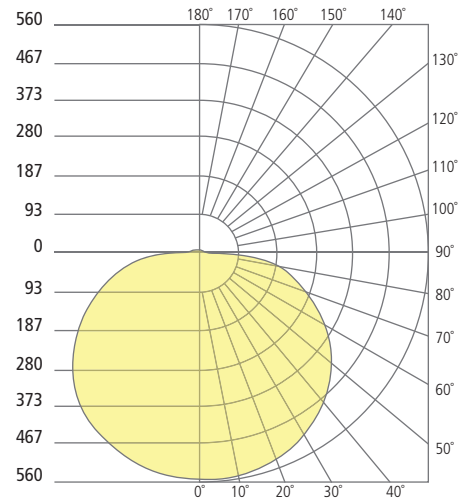
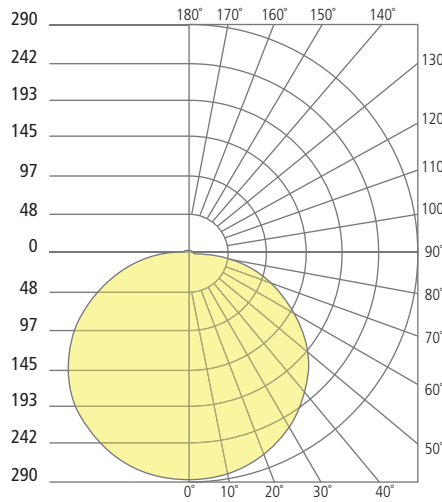
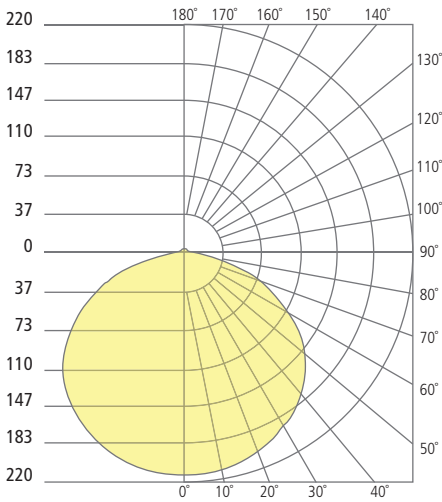

### PROJECT INFO

FIXTURE TYPE & QUANTITY

JOB NAME & INFO

NOTES

---



---



---



---



---



---



© 2016 Tech Lighting, L.L.C. All rights reserved. The "Tech Lighting" graphic is a registered trademark of Tech Lighting, L.L.C. Tech Lighting reserves the right to change specifications for product improvements without notification.

**ELEMENT**  
by Tech Lighting

GENERATION BRANDS  
7400 Linder Avenue, Skokie, Illinois 60077  
T 847.410.4400 F 847.410.4500