

ELEMENT™ 3" LED

REMODEL NON-IC ADJUSTABLE DOWNLIGHT

The ELEMENT 3" Remodel Adjustable Downlight blends stunning architectural aesthetics with exceptional performance and brings it to remodel applications with style. Experience complete adjustability with hot aiming for effortless precision, while ELEMENT's patented high/low lamp positioning lets you optimize LED placement for maximum light output and efficiency, or reduction of glare and trim flash. The ELEMENT 3" Remodel Adjustable Downlight offers premium LED options with Static White, Warm Dim, and Xicato.

- SDCM: 1-step static white and 2-step warm dim
- 0-40° tilt + 361° rotation, and high/low lamp positioning (patented)
- Interchangeable optics: 10°, 18°, 25°, 40°, 60°
- Up to 19,414 CBCP delivered
- Flanged/flangeless die-cast Bevel and Flat trims
- Trims match the ELEMENT 3" platform



LUMEN/CBCP MULTIPLIERS

CCT	80 CRI MULTIPLIER	90 CRI MULTIPLIER
2700K	1.12	0.98
3000K	1.18	1.00
3500K	1.22	1.01

Lumen output will vary by CCT and CRI. See photometric charts for output information.

SPECIFICATIONS

	STATIC WHITE		XICATO		WARM DIM	
	HIGH OUTPUT	LOW OUTPUT	STANDARD SERIES	ARTIST SERIES	HIGH OUTPUT	LOW OUTPUT
DELIVERED LUMENS	1697/1440	1303/1106	1129	945	1225	941
WATTS	16	12	15	15	16	12
EFFICACY	106/90	109/92	75	63	77	78
CRI	80+/90+		80+	95+	90+	
CBCP	10° - 24,575 18° - 5,639 25° - 5,033 40° - 2,739 60° - 1,699		43° - 2,733 60° - 1,014 (Values at 80 CRI)		18° - 4,793 25° - 4,221 40° - 2,328 60° - 1,444	
CCT	2700K, 3000K, or 3500K		2700K, 3000K, or 3500K	2700K or 3000K	3000K - 1800K	
COLOR CONSISTENCY	1-step		1 X 2-step		2-step	
VOLTAGE	120V or 277V					
DIMMING ¹	Standard reverse-phase, forward-phase, TRIAC, and 0-10V dimming down to 1% eidoLED 0-10V or DALI-2 down to 0.1%					
POWER SUPPLY	Constant current driver with +.9 power factor and +80% efficiency					
OPTICS	Field changeable: 18°, 25°, 40°, or 60° TIR Not field changeable: 10° TIR		Field changeable: 43° or 60° reflector		Field changeable: 18°, 25°, 40°, or 60° TIR	
ADJUSTABILITY	Lockable, hot-aiming 0-40° tilt, 361° rotation, high/low lamp positioning					
CEILING APPEARANCE	Flanged or Flangeless					
CEILING THICKNESS	Flanged square: Up to 2-1/2" Flanged round: Up to 1" Flangeless: No ceiling thickness limitations Note: Thicker ceilings impact light cutoff					
CEILING APERTURE	Flanged: 4" ceiling cutout Flangeless: 5" ceiling cutout					
HOUSING	Non-IC					
CONSTRUCTION	Trim: Die-cast aluminum					
FINISH	Trim: Antique Bronze, Black, Satin Nickel, or White (paintable)					
GENERAL LISTINGS	ETL Listed. Damp Location. Shower version Wet Listed.					
L70	50,000 hours min					
WARRANTY ²	5 years					

Data in chart reflect 3000K/90 CRI values unless noted.
Custom output/custom RAL/custom CCT available, contact Quotes Department

Ordering grids available on page 2.

¹See visualcomfort.com for dimmer compatibility.

²Visit visualcomfort.com for specific warranty limitations and details.

ELEMENT™ 3" LED

REMODEL NON-IC ADJUSTABLE DOWNLIGHT

ORDERING GRIDS

HOUSING

PRODUCT	CEILING APPEARANCE	LAMP	CRI/CCT	BEAM SPREAD	FUNCTION	HOUSING RATING	DRIVER	VOLTAGE
E3R ELEMENT 3" ROUND	RL REMODEL FLANGELESS	-LH HIGH OUTPUT, 16W	827 80 CRI, 2700K, 1-STEP 830 80 CRI, 3000K, 1-STEP	0 10° ² 1 18° 2 20° 4 40° 6 60°	A ADJUSTABLE	N NON-IC	UNIVERSAL PHASE/0-10V 1% (LEAVE BLANK) ⁴	120 VOLT (LEAVE BLANK)
E3S ELEMENT 3" SQUARE	RF REMODEL FLANGED ¹	-LO LOW OUTPUT, 12W	927 90 CRI, 2700K, 1-STEP 930 90 CRI, 3000K, 1-STEP 935 90 CRI, 3500K, 1-STEP WD 90 CRI, 3000-1800K, WARM DIM, 2-STEP				-ELDO ELDOLED 0.1% 0-10V LINEAR -ELDOA ELDOLED 0.1% 0-10V LOGARITHMIC -ELDD ELDOLED 0.1% DALI-2	-277 277 VOLT ⁴
		-X XICATO, HIGH OUTPUT, 14W ³	I27 80 CRI, 2700K, 1X2-STEP, XICATO I30 80 CRI, 3000K, 1X2-STEP, XICATO I35 80 CRI, 3500K, 1X2-STEP, XICATO A27 95 CRI, 2700K, 1X2-STEP, XICATO ARTIST A30 95 CRI, 3000K, 1X2-STEP, XICATO ARTIST	43 43° XICATO 60 60° XICATO				
A						N		-

Trims are required and must be ordered separately.

For dimming details, refer to dimmer compatibility chart.

¹RF - Round flanged accommodates up to 1" max ceiling thickness.

²0 - 10° optic has a unique LED module not available with warm dim. To change optics to 18°, 25°, 40°, or 60° a new LED module is required, please contact Customer Service.

³X - XICATO housings utilize dedicated standard phase, 0-10V, 120V and 277V drivers. If ordering Xicato with standard drivers (non-eldoLED), at the end of the item number please specify:

-010 for 0-10V 120V, **-277** for Phase 277V or **-010-277** for 0-10V 277. For example: E3RLF-XA2743DI-**010** or E3RLF-XA2743DI-**277** or E3RLF-XA2743DI-**010-277**. Due to the size of some of the Xicato Reflectors, it may not be feasible to tilt the fixture in the 'low' position. It is still tiltable in the 'high' position.

⁴Universal dimming is reverse-phase, forward-phase, TRIAC and 0-10V. 277V is only compatible with 0-10V dimming.

TRIM

PRODUCT	CEILING APPEARANCE	STYLE	APERTURE	FINISH
E3R ELEMENT 3" ROUND	L FLANGELESS	B BEVEL	-O NO LENS -H SHOWER ¹ -L LENSED	Z ANTIQUE BRONZE B BLACK S SATIN NICKEL W WHITE
E3S ELEMENT 3" SQUARE	F FLANGED	F FLAT		
-				

Trims are required and must be ordered separately.

¹H - Shower lens includes a gasket.

REPLACEMENT OPTICS

PRODUCT	BEAM SPREAD
353E4LEDCOPT	18 18° 25 25° 40 40° 60 60°
353E4LEDCOPT	

REPLACEMENT REFLECTORS

PRODUCT ¹	BEAM SPREAD
352LEDXREF	43 43° 60 60°
352LEDXREF	

¹For use with Xicato modules only.

WALL WASH TRIM

PRODUCT	CEILING APPEARANCE	STYLE	APERTURE	LED
E3R ELEMENT 3" ROUND	L FLANGELESS	W WALL WASH	-Z ANTIQUE BRONZE -B BLACK -S SATIN NICKEL -W WHITE	-LED
E3S ELEMENT 3" SQUARE	F FLANGED			
W				
-				
-LED				

FROSTED BOROSILICATE LENS KIT

PRODUCT	
240E3SBLSP-B	BOROSILICATE LENS KIT E3 SQUARE BEVEL TRIM
240E3SQLSP-B	BOROSILICATE LENS KIT E3 SQUARE FLAT TRIM
240E3RBLSP-B	BOROSILICATE LENS KIT E3 ROUND BEVEL TRIM
240E3RDLSP-B	BOROSILICATE LENS KIT E3 ROUND FLAT TRIM

Includes frosted borosilicate lens, lens spring, and screws to mount to ELEMENT 3" trim.

LENSES/LOUVERS

PRODUCT ¹	
140MR16SF	SOLITE SOFT FOCUS LENS
140MR16SB	SANDBLASTED LENS
140MR16LL	LINEAR SPREAD LENS
140MR16DF	DIFFUSER SPREAD LENS
EL2RHCBK	EGGCRATE/HEXCELL LOUVER

¹For additional lenses, louvers, optical controls and accessories, reference visualcomfort.com. Lens/louvers mounted to lamp assembly only (max 2).

PREMIUM LENS HOLDER

PRODUCT	LENSES
240E3LENSHLDR	1 ONE LENS 2 TWO LENSES
240E3LENSHLDR	

240E3LENSHLDR

The premium, threaded lens holder provides more secure mounting of additional lenses as compared to the standard lens holder that ships with each fixture. The premium lens holder is not compatible with the 10° beam spread.

PLASTER PLATES

PRODUCT ¹	
150E3RPPLT-A	3" PLASTER PLATE ROUND DIE-CAST METAL ¹
150E3SPPLT-A	3" PLASTER PLATE SQUARE DIE-CAST METAL ¹
150E3RTPPLT-W	3" PLASTER PLATE ROUND SHEET METAL ²
150E3STPPLT-W	3" PLASTER PLATE SQUARE SHEET METAL ²

Plaster plates are used to convert flanged housings into flangeless housings.

¹Ships standard with flangeless housings. Round not compatible with Lutron Hi-lume or eldoLED drivers.

²Optional, thinner, meshed sheet metal mud plates available for minimized plaster feathering to meet installer preference. Round not compatible with Lutron Hi-lume or eldoLED drivers. Square not compatible with eldoLED drivers.

ELEMENT™ 3" LED

REMODEL NON-IC ADJUSTABLE DOWNLIGHT

TRIMS

FLANGED

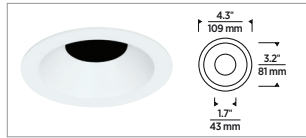

ROUND BEVEL

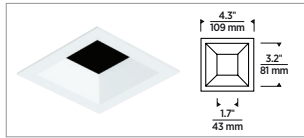

SQUARE BEVEL

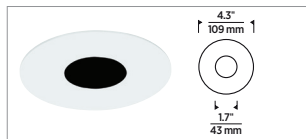

ROUND FLAT

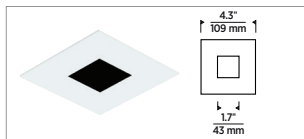

SQUARE FLAT

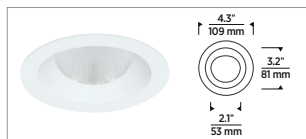

ROUND WALL WASH

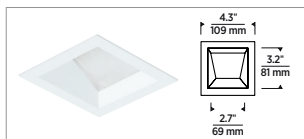

SQUARE WALL WASH

FLANGELESS

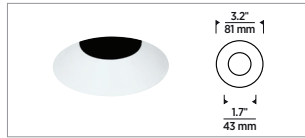

ROUND BEVEL

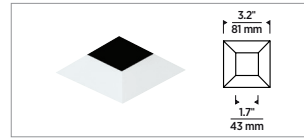

SQUARE BEVEL

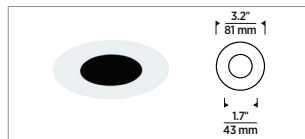

ROUND FLAT

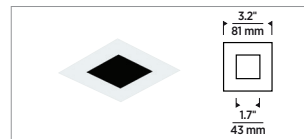

SQUARE FLAT



ROUND WALL WASH



SQUARE WALL WASH

FINISH



ANTIQU
BRONZE



BLACK



SATIN
NICKEL



WHITE
(PAINTABLE)

LENS OPTION



SHOWN WITH AND WITHOUT A LENS (SQUARE FLANGED BEVEL)



SHOWN WITH AND WITHOUT A LENS (ROUND FLANGELESS BEVEL)

ELEMENT™ 3" LED

REMODEL NON-IC ADJUSTABLE DOWNLIGHT

WARM DIM CURVE

CCT vs. Forward Current, $T_c=25^\circ\text{C}$

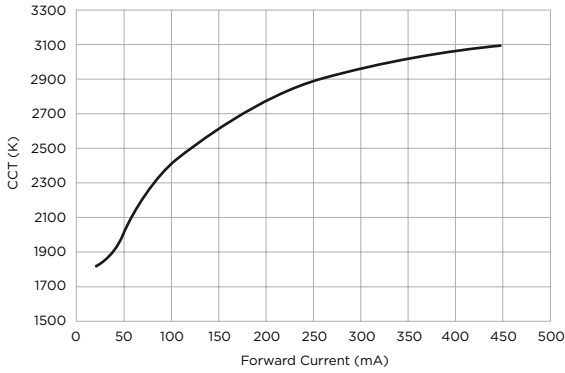

3" MECHANISM

ROUND

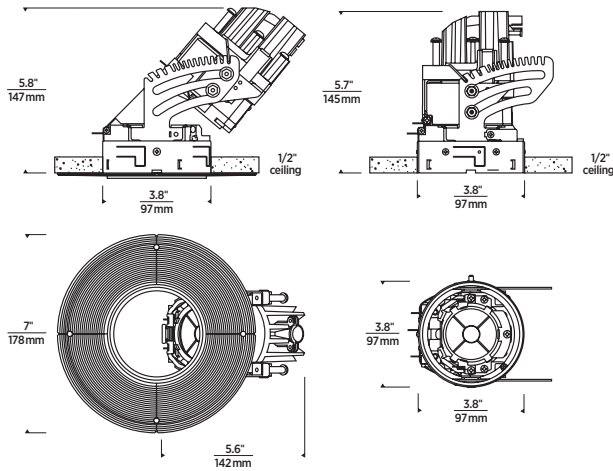

SHOWN IN ROUND FLANGELESS AT FULL TILT (40°)

SHOWN IN ROUND FLANGED AT NO TILT (0°)

SQUARE

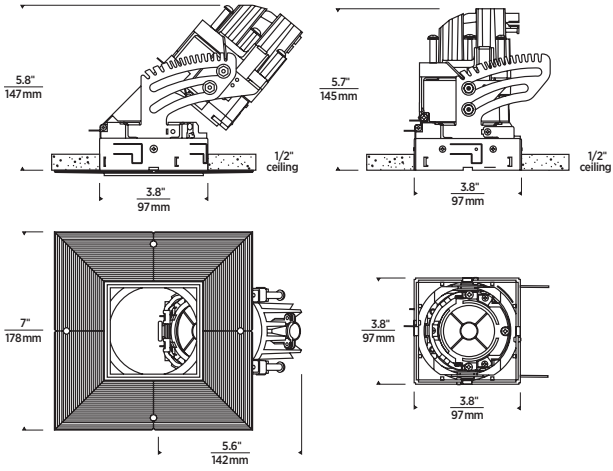

SHOWN IN SQUARE FLANGELESS AT FULL TILT (40°)

SHOWN IN SQUARE FLANGED AT NO TILT (0°)

J-BOX / DRIVERS

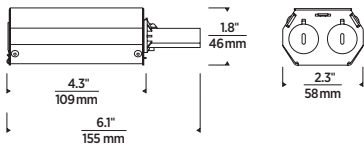

ELEMENT™ 3" LED

























REMODEL NON-IC ADJUSTABLE DOWNLIGHT

TRIM-MOUNTED REFLECTORS

ELEMENT Specular Reflectors reduce glare while creating a clean, quiet ceiling appearance. Available finishes include Silver for a decorative accent or Anodized Black for an ultimate quiet ceiling aesthetic. These beautiful trim accessories have been specifically designed to minimize any effect on light performance, color and output. Specular Reflectors are available for both Adjustable and Fixed downlights and are compatible with ELEMENT 3" trims and housings.

- Can be easily installed or removed
- Assembles to existing trim
- Compatible with Fixed and Adjustable Housings
- Finish Options: Anodized Black (B) or Anodized Silver (S)

SPECIFICATIONS

COMPATIBLE TRIMS	NON-SLOTTED (FOR FIXED ¹)	SLOTTED (FOR ADJUSTABLE)
 3" round, flanged, bevel	 E3TREFNS1 (B OR S)	 E3TREFS4 (B OR S)
 3" square, flanged, bevel	 E3TREFNS5 (B OR S)	 E3TREFS1 (B OR S)
 3" round, flanged, flat	 E3TREFNS1 (B OR S)	 E3TREFS4 (B OR S)
 3" square, flanged, flat	 E3TREFNS3 (B OR S)	 E3TREFS2 (B OR S)
 3" round, flangeless, bevel	 E3TREFNS2 (B OR S)	 E3TREFS6 (B OR S)
 3" square, flangeless, bevel	 E3TREFNS6 (B OR S)	 E3TREFS5 (B OR S)
 3" round, flangeless, flat	 E3TREFNS4 (B OR S)	 E3TREFS3 (B OR S)
 3" square, flangeless, flat	 E3TREFNS3 (B OR S)	 E3TREFS2 (B OR S)

May require lamp to be placed in high position.
Not compatible with lensed trims.

¹Non-slotted reflectors may be used in adjustable housings with the lamp assembly placed in the 0° tilt position.

ORDERING GRID

E3 TRIM-MOUNTED REFLECTORS

PRODUCT	STYLE	FINISH
E3TREF	NS1 NON-SLOTTED	B ANODIZED BLACK
	NS2 NON-SLOTTED	S ANODIZED SILVER
	NS3 NON-SLOTTED	
	NS4 NON-SLOTTED	
	NS5 NON-SLOTTED	
	NS6 NON-SLOTTED	
	S1 SLOTTED	
	S2 SLOTTED	
	S3 SLOTTED	
	S4 SLOTTED	
	S5 SLOTTED	
	S6 SLOTTED	

E3TREF

Reflectors are placed on top of the inside of the trim or affixed via screws (only if provided).

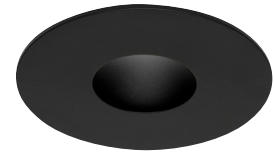

SHOWN IN ANODIZED BLACK
(BELOW CEILING VIEW)



SHOWN IN ANODIZED SILVER
(BELOW CEILING VIEW)



SHOWN IN ANODIZED SILVER
(BELOW CEILING VIEW)



SHOWN IN ANODIZED BLACK
(TRIM MOUNTED)



SHOWN IN ANODIZED BLACK AND
SILVER (REFLECTOR ONLY)

ELEMENT™ 3" LED

REMODEL NON-IC ADJUSTABLE DOWNLIGHT

PHOTOMETRICS

Description: 3" LED Module
10° Beam, 0° Tilt
90 CRI, 3000K

Input Power: 18.2W
Input Power Factor: 0.99
Absolute Luminous Flux (Lumens): 987
Lumen Efficacy (Lumens per Watt): 54.2

Description: 3" LED Module
18° Beam, 0° Tilt
90 CRI, 3000K

Input Power: 15.8W
Input Power Factor: 0.98
Absolute Luminous Flux (Lumens): 1278
Lumen Efficacy (Lumens per Watt): 80.9

Description: 3" LED Module
25° Beam, 0° Tilt
90 CRI, 3000K

Input Power: 15.8W
Input Power Factor: 0.98
Absolute Luminous Flux (Lumens): 1421
Lumen Efficacy (Lumens per Watt): 89.9

Output difference between CCTs - 5%, CRIs - 15%.

ANGLE	0°	45°	90°
0°	24575	24575	24575
5°	12004	10898	12296
10°	1418	1275	1517
15°	355	332	340
20°	171	165	154
25°	90	85	87
30°	52	48	49
35°	33	31	32
40°	21	19	19
45°	10	11	8
50°	3	6	3
55°	2	2	2
60°	1	1	1
65°	0	0	0
70°	0	0	0
75°	0	0	0
80°	0	0	0
85°	0	0	0
90°	0	0	0

ANGLE	0°	45°	90°
0°	5546	5546	5546
5°	4951	5044	4838
10°	3208	3326	3167
15°	1748	1859	1721
20°	882	1028	871
25°	395	485	380
30°	171	195	167
35°	83	84	81
40°	49	52	50
45°	29	34	30
50°	14	22	13
55°	12	15	11
60°	11	12	9
65°	7	10	6
70°	6	6	6
75°	5	6	5
80°	5	5	5
85°	5	5	5
90°	4	5	5

ANGLE	0°	45°	90°
0°	4966	4966	4966
5°	4647	4710	4525
10°	3677	3750	3542
15°	2292	2346	2143
20°	1103	1188	986
25°	465	559	417
30°	211	240	187
35°	98	100	89
40°	53	56	50
45°	30	35	29
50°	16	22	14
55°	11	13	10
60°	9	9	8
65°	8	7	7
70°	7	6	6
75°	6	6	6
80°	6	5	5
85°	5	5	5
90°	5	5	5

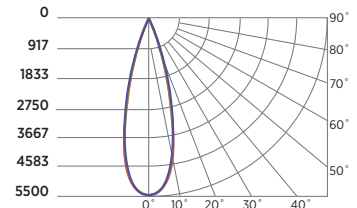
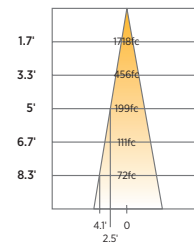
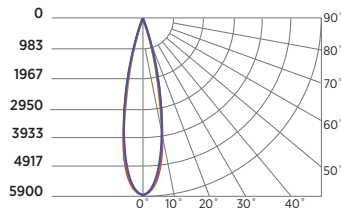
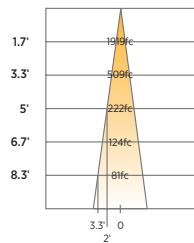
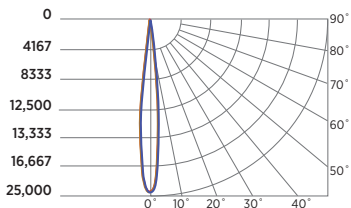
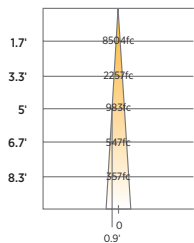

ELEMENT™ 3" LED

REMODEL NON-IC ADJUSTABLE DOWNLIGHT

PHOTOMETRICS

Description: 3" LED Module
40° Beam, 0° Tilt
90 CRI, 3000K

Input Power: 15.8W

Input Power Factor: 0.98

Absolute Luminous Flux (Lumens): 1440

Lumen Efficacy (Lumens per Watt): 91.1

Output difference between CCTs - 5%, CRIs - 15%.

Description: 3" LED Module
60° Beam, 0° Tilt
90 CRI, 3000K

Input Power: 15.7W

Input Power Factor: 0.98

Absolute Luminous Flux (Lumens): 1343

Lumen Efficacy (Lumens per Watt): 85.5

ANGLE	0°	45°	90°
0°	2729	2729	2729
5°	2686	2706	2649
10°	2503	2538	2439
15°	2147	2183	2100
20°	1617	1683	1572
25°	915	1000	904
30°	388	434	375
35°	153	162	157
40°	70	77	71
45°	31	41	32
50°	10	21	11
55°	7	10	7
60°	4	6	4
65°	3	4	3
70°	3	3	13
75°	2	3	2
80°	2	2	2
85°	2	2	2
90°	1	2	2

ANGLE	0°	45°	90°
0°	1699	1699	1699
5°	1654	1654	1654
10°	1548	1548	1548
15°	1403	1403	1403
20°	1163	1163	1163
25°	854	854	854
30°	580	580	580
35°	374	374	374
40°	219	219	219
45°	112	112	112
50°	48	48	48
55°	23	23	23
60°	9	9	9
65°	7	7	7
70°	6	6	6
75°	6	6	6
80°	5	5	5
85°	5	5	5
90°	5	5	5

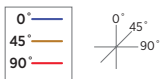
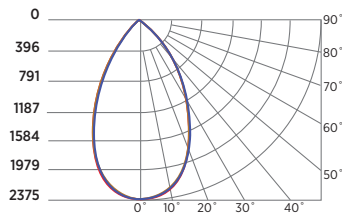
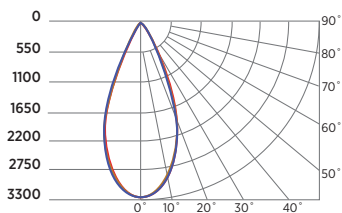
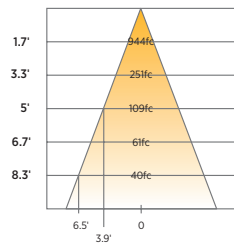
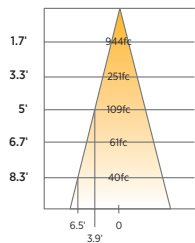

ELEMENT™ 3" LED

REMODEL NON-IC ADJUSTABLE DOWNLIGHT

PROJECT INFORMATION

JOB NAME AND INFORMATION

FIXTURE TYPE AND QUANTITY

NOTES
