

ELEMENT™ 3" LED

WOODALIGN ADJUSTABLE DOWNLIGHT

Achieve perfection in wood ceiling lighting with the ELEMENT 3" LED WoodAlign Adjustable Downlight. Designed exclusively for flangeless wood ceilings, our downlight guarantees that every trim is flawlessly centered within each wood plank, ensuring an impeccable and consistent aesthetic. Boasting a versatile 0°-40° tilt and a full 361° rotation, precise aiming has never been easier. Choose from either square or round die-cast trims in beveled or flat finishes to seamlessly integrate with ELEMENT's new construction designs. Experience the ultimate blend of streamlined installation and unmatched elegance.

- Unique installation ensures every trim is perfectly centered within each wood plank
- Aiming and locking: 0-40° tilt and 361° rotation
- Trims match the ELEMENT 3" platform
- Standard dimming down to 1%
- Trim reflector options available
- Solite Soft Focus lens option
- 1-step static white, 2-step warm dim



LUMEN/CBCP MULTIPLIERS

CCT	80 CRI MULTIPLIER	90 CRI MULTIPLIER
2700K	1.12	0.98
3000K	1.18	1.00
3500K	1.22	1.01

Lumen output will vary by CCT and CRI. See photometric charts for output information.

SPECIFICATIONS

	STATIC WHITE		WARM DIM	
	HIGH OUTPUT	LOW OUTPUT	HIGH OUTPUT	LOW OUTPUT
DELIVERED LUMENS	1697/1298	1175/997	1225	941
WATTS	16	12	16	12
EFFICACY	106/81	98/83	77	78
CRI	80+/90+		90+	
CBCP	10° - 9,608 18° - 5,657 25° - 4,720 40° - 2,655 60° - 1,700		18° - 4,793 25° - 4,306 40° - 2,335 60° - 1,444	
CCT	2700K, 3000K, or 3500K		3000K - 1800K	
COLOR CONSISTENCY	1-step		2-step	
VOLTAGE	120V or 277V			
DIMMING ¹	Standard reverse-phase, forward-phase, TRIAC, and 0-10V dimming down to 1% eLdoLED 0-10V or DALI-2 down to 0.1% Lutron Hi-lume EcoSystem down to 0.1%			
POWER SUPPLY	Constant current driver with +.9 power factor and +80% efficiency			
OPTICS	Field changeable: 18°, 25°, 40°, or 60° TIR Not field changeable: 10° TIR		Field changeable: 18°, 25°, 40°, or 60° TIR	
ADJUSTABILITY	Lockable, hot-aiming 0-40° tilt, 361° rotation			
CEILING APPEARANCE	Flangeless			
CEILING THICKNESS	Shim or route to 3/4"			
CEILING APERTURE	3.5" ceiling cutout			
HOUSING	Non-IC			
CONSTRUCTION	Trim: Die-cast aluminum			
FINISH	Trim: Antique Bronze, Black, Satin Nickel, or White (paintable)			
GENERAL LISTINGS	ETL Listed. Damp Location. Shower version Wet Listed.			
L70	50,000 hours min			
WARRANTY ²	5 years			

Data in chart reflect 3000K/90 CRI values unless noted.
Custom output/custom RAL/custom CCT available, contact Quotes Department

Ordering grids available on page 2.

¹See visualcomfort.com for dimmer compatibility.

²Visit visualcomfort.com for specific warranty limitations and details.

ELEMENT™ 3" LED

WOODALIGN ADJUSTABLE DOWNLIGHT

ORDERING GRIDS

HOUSING

PRODUCT	CEILING APPEARANCE	LAMP	CRI/CCT	BEAM SPREAD	FUNCTION	HOUSING RATING	DRIVER
E3R ELEMENT 3" ROUND	LW FLANGELESS	-LH HIGH OUTPUT, 17W	827 80 CRI, 2700K, 1-STEP	0 10° ²	A ADJUSTABLE	N NON-IC	INTEGRATED DRIVERS 120V/277V 120V UNIVERSAL PHASE/0-10V 1% (LEAVE BLANK) ³ 277V PHASE 0-10V 1% ³
E3S ELEMENT 3" SQUARE	WOODALIGN ¹	-LO LOW OUTPUT, 12W	830 80 CRI, 3000K, 1-STEP	1 18°			
			835 80 CRI, 3500K, 1-STEP	2 25°			
			927 90 CRI, 2700K, 1-STEP	4 40°			
			930 90 CRI, 3000K, 1-STEP	6 60°			
			935 90 CRI, 3500K, 1-STEP				
			WD 90 CRI, 3000-1800K, WARM DIM, 2-STEP ²				
	LW	-			A	N	REMOTE DRIVERS -ELDO ELDOLED 0.1% 0-10V LINEAR -ELDOA ELDOLED 0.1% 0-10V LOGARITHMIC -ELDD ELDOLED 0.1% DALI-2 -HLECO LUTRON HI-LUME 0.1% ECOSYSTEM

Trims are required and must be ordered separately.

For dimming details, refer to dimmer compatibility chart.

¹LW - Shim or route ceiling to 3/4" thickness. Minimum plank width 4.5".

²0 - 10° optic has a unique LED module which is not available in warm dim. To change optics to 18°, 25°, 40°, or 60° a new LED module is required, please contact Customer Service.

³Universal dimming is reverse-phase, forward-phase, TRIAC and 0-10V. 277V is only compatible with 0-10V dimming.

TRIM

PRODUCT	CEILING APPEARANCE	STYLE	APERTURE	FINISH
E3R ELEMENT 3" ROUND	L FLANGELESS	B BEVEL	-O NO LENS	Z ANTIQUE BRONZE
E3S ELEMENT 3" SQUARE		F FLAT	-H SHOWER ¹	B BLACK
			-L LENSED	S SATIN NICKEL
				W WHITE
	L	-		

Trims are required and must be ordered separately.

¹H - Shower trim includes a gasket and lens.

REPLACEMENT OPTICS

PRODUCT	BEAM SPREAD
353E4LEDCOPT	18 18°
	25 25°
	40 40°
	60 60°
353E4LEDCOPT	

WALL WASH TRIM

PRODUCT	CEILING APPEARANCE	STYLE	APERTURE	LED
E3R ELEMENT 3" ROUND	L FLANGELESS	W WALL WASH	-Z ANTIQUE BRONZE	-LED
E3S ELEMENT 3" SQUARE			-B BLACK	
			-S SATIN NICKEL	
			-W WHITE	
	L	W	-	-LED

FROSTED BOROSILICATE LENS KIT

PRODUCT	
240E3SBLSP-B	BOROSILICATE LENS KIT E3 SQUARE BEVEL TRIM
240E3SQLSP-B	BOROSILICATE LENS KIT E3 SQUARE FLAT TRIM
240E3RBLSP-B	BOROSILICATE LENS KIT E3 ROUND BEVEL TRIM
240E3RDLSP-B	BOROSILICATE LENS KIT E3 ROUND FLAT TRIM

Includes frosted borosilicate lens, lens spring, and screws to mount to ELEMENT 3" trim.

LENSES/LOUVERS

PRODUCT ¹	
140MR16SF	SOLITE SOFT FOCUS LENS
140MR16SB	SANDBLASTED LENS
140MR16LL	LINEAR SPREAD LENS
140MR16DF	DIFFUSER SPREAD LENS
EL2RHCBK	EGGCRATE/HEXCELL LOUVER

¹For additional lenses, louvers, optical controls and accessories, reference visualcomfort.com. Lens/louvers mounted to lamp assembly only (max 2).

PREMIUM LENS HOLDER

PRODUCT	LENSES
240E3LENSHLDR	1 ONE LENS
	2 TWO LENSES
240E3LENSHLDR	

The premium, threaded lens holder provides more secure mounting of additional lenses as compared to the standard lens holder that ships with each fixture. The premium lens holder is not compatible with the 10° beam spread.

ROUTER TEMPLATE

PRODUCT	LENSES
E3WCRT	-R ROUND TEMPLATE
	-S SQUARE TEMPLATE
E3WCRT	



ELEMENT™ 3" LED

WOODALIGN ADJUSTABLE DOWNLIGHT

TRIMS

FLANGELESS

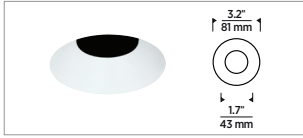

ROUND BEVEL

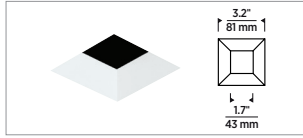

SQUARE BEVEL

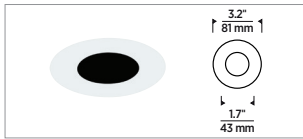

ROUND FLAT

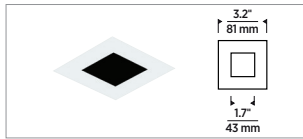

SQUARE FLAT

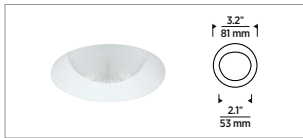

ROUND WALL WASH

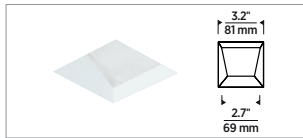

SQUARE WALL WASH

FINISH



ANTIQUE BRONZE



BLACK



SATIN NICKEL



WHITE (PAINTABLE)

LENS OPTION



SHOWN WITH AND WITHOUT A LENS (SQUARE FLANGELESS BEVEL)



SHOWN WITH AND WITHOUT A LENS (ROUND FLANGELESS BEVEL)

ELEMENT™ 3" LED

WOODALIGN ADJUSTABLE DOWNLIGHT

WARM DIM CURVE

CCT vs. Forward Current, $T_c=25^\circ\text{C}$

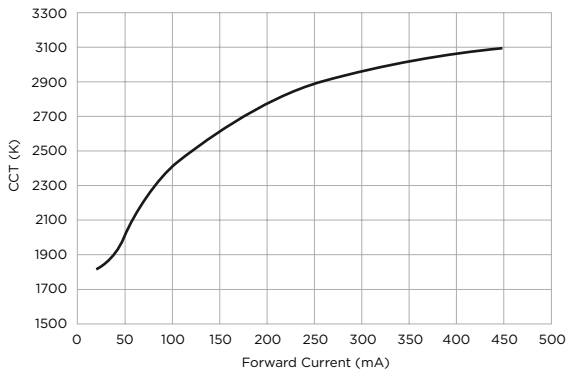

3" MECHANISM

ROUND

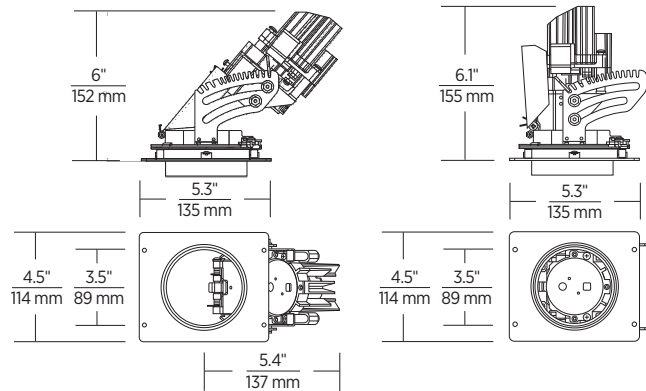

SHOWN IN ROUND AT FULL TILT (40°)

SHOWN IN ROUND AT NO TILT (0°)

SQUARE

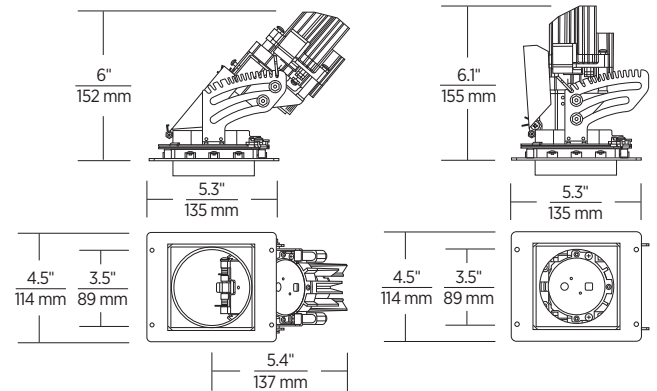

SHOWN IN SQUARE AT FULL TILT (40°)

SHOWN IN SQUARE AT NO TILT (0°)

J-BOX / DRIVERS

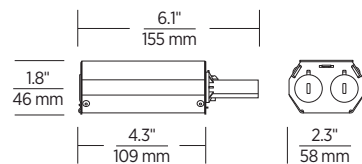

The mechanism must be in a greater than 5 degree tilt during rotation to avoid interference with the lens assembly. It may be returned to the 0 degree position once rotational aiming is complete.

ELEMENT™ 3" LED













WOODALIGN ADJUSTABLE DOWNLIGHT

TRIM-MOUNTED REFLECTORS

ELEMENT Specular Reflectors reduce glare while creating a clean, quiet ceiling appearance. Available finishes include Silver for a decorative accent or Anodized Black for an ultimate quiet ceiling aesthetic. These beautiful trim accessories have been specifically designed to minimize any effect on light performance, color and output. Specular Reflectors are available for both Adjustable and Fixed downlights and are compatible with ELEMENT 3" trims and housings.

- Can be easily installed or removed
- Assembles to existing trim
- Compatible with Fixed and Adjustable Housings
- Finish Options: Anodized Black (B) or Anodized Silver (S)

SPECIFICATIONS

COMPATIBLE TRIMS	NON-SLOTTED (FOR FIXED ¹)	SLOTTED (FOR ADJUSTABLE)
 3" round, flangeless, bevel	 E3TREFNS2 (B OR S)	 E3TREFS6 (B OR S)
 3" square, flangeless, bevel	 E3TREFNS6 (B OR S)	 E3TREFS5 (B OR S)
 3" round, flangeless, flat	 E3TREFNS4 (B OR S)	 E3TREFS3 (B OR S)
 3" square, flangeless, flat	 E3TREFNS3 (B OR S)	 E3TREFS2 (B OR S)

¹May require lamp to be placed in high position.

Not compatible with lensed trims.

²Non-slotted reflectors may be used in adjustable housings with the lamp assembly placed in the 0° tilt position.



SHOWN IN ANODIZED BLACK AND SILVER (REFLECTOR ONLY)

ORDERING GRID

E3 TRIM-MOUNTED REFLECTORS

PRODUCT	STYLE	FINISH
E3TREF	NS2 NON-SLOTTED	B ANODIZED BLACK
	NS3 NON-SLOTTED	
	NS4 NON-SLOTTED	S ANODIZED SILVER
	NS6 NON-SLOTTED	
	S2 SLOTTED	
	S3 SLOTTED	
	S5 SLOTTED	
	S6 SLOTTED	

E3TREF

Reflectors are placed on top of the inside of the trim or affixed via screws (only if provided).

ELEMENT™ 3" LED

WOODALIGN ADJUSTABLE DOWNLIGHT

PHOTOMETRICS

Description: 3" LED Module
10° Beam, 0° Tilt
90 CRI, 3000K

Input Power: 18.2W
Input Power Factor: 0.99
Absolute Luminous Flux (Lumens): 987
Lumen Efficacy (Lumens per Watt): 54.2

Description: 3" LED Module
18° Beam, 0° Tilt
90 CRI, 3000K

Input Power: 15.8W
Input Power Factor: 0.98
Absolute Luminous Flux (Lumens): 1278
Lumen Efficacy (Lumens per Watt): 80.9

Description: 3" LED Module
25° Beam, 0° Tilt
90 CRI, 3000K

Input Power: 15.8W
Input Power Factor: 0.98
Absolute Luminous Flux (Lumens): 1421
Lumen Efficacy (Lumens per Watt): 89.9

Output difference between CCTs - 5%, CRIs - 15%.

ANGLE	0°	45°	90°
0°	24575	24575	24575
5°	12004	10898	12296
10°	1418	1275	1517
15°	355	332	340
20°	171	165	154
25°	90	85	87
30°	52	48	49
35°	33	31	32
40°	21	19	19
45°	10	11	8
50°	3	6	3
55°	2	2	2
60°	1	1	1
65°	0	0	0
70°	0	0	0
75°	0	0	0
80°	0	0	0
85°	0	0	0
90°	0	0	0

ANGLE	0°	45°	90°
0°	5546	5546	5546
5°	4951	5044	4838
10°	3208	3326	3167
15°	1748	1859	1721
20°	882	1028	871
25°	395	485	380
30°	171	195	167
35°	83	84	81
40°	49	52	50
45°	29	34	30
50°	14	22	13
55°	12	15	11
60°	11	12	9
65°	7	10	6
70°	6	6	6
75°	5	6	5
80°	5	5	5
85°	5	5	5
90°	4	5	5

ANGLE	0°	45°	90°
0°	4966	4966	4966
5°	4647	4710	4525
10°	3677	3750	3542
15°	2292	2346	2143
20°	1103	1188	986
25°	465	559	417
30°	211	240	187
35°	98	100	89
40°	53	56	50
45°	30	35	29
50°	16	22	14
55°	11	13	10
60°	9	9	8
65°	8	7	7
70°	7	6	6
75°	6	6	6
80°	6	5	5
85°	5	5	5
90°	5	5	5

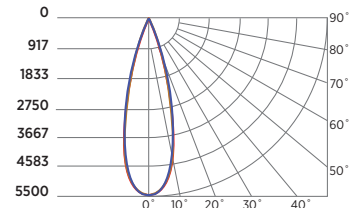
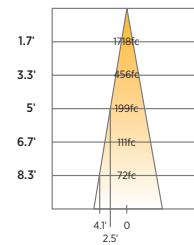
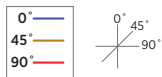
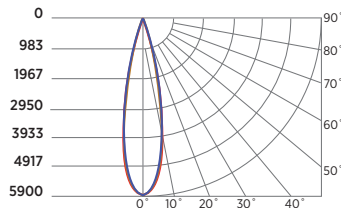
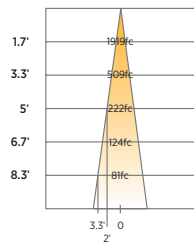
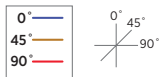
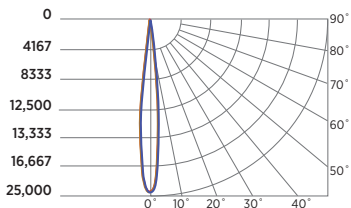
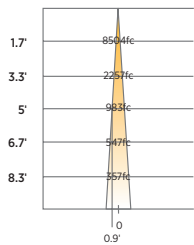

ELEMENT™ 3" LED

WOODALIGN ADJUSTABLE DOWNLIGHT

PHOTOMETRICS

Description: 3" LED Module
40° Beam, 0° Tilt
90 CRI, 3000K

Input Power: 15.8W

Input Power Factor: 0.98

Absolute Luminous Flux (Lumens): 1440

Lumen Efficacy (Lumens per Watt): 91.1

Description: 3" LED Module
60° Beam, 0° Tilt
90 CRI, 3000K

Input Power: 15.7W

Input Power Factor: 0.98

Absolute Luminous Flux (Lumens): 1343

Lumen Efficacy (Lumens per Watt): 85.5

Output difference between CCTs - 5%, CRIs - 15%.

ANGLE	0°	45°	90°
0°	2729	2729	2729
5°	2686	2706	2649
10°	2503	2538	2439
15°	2147	2183	2100
20°	1617	1683	1572
25°	915	1000	904
30°	388	434	375
35°	153	162	157
40°	70	77	71
45°	31	41	32
50°	10	21	11
55°	7	10	7
60°	4	6	4
65°	3	4	3
70°	3	3	13
75°	2	3	2
80°	2	2	2
85°	2	2	2
90°	1	2	2

ANGLE	0°	45°	90°
0°	1699	1699	1699
5°	1654	1654	1654
10°	1548	1548	1548
15°	1403	1403	1403
20°	1163	1163	1163
25°	854	854	854
30°	580	580	580
35°	374	374	374
40°	219	219	219
45°	112	112	112
50°	48	48	48
55°	23	23	23
60°	9	9	9
65°	7	7	7
70°	6	6	6
75°	6	6	6
80°	5	5	5
85°	5	5	5
90°	5	5	5

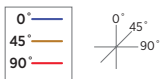
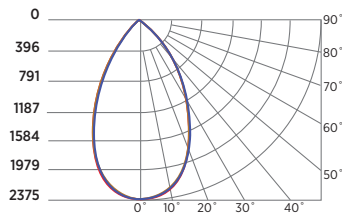
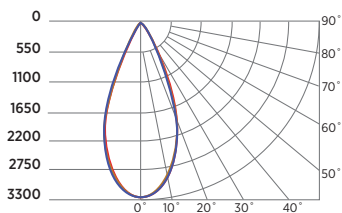
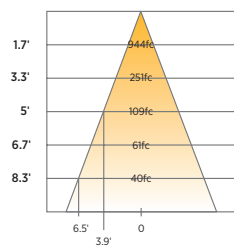
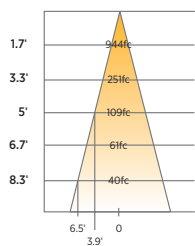

ELEMENT™ 3" LED

WOODALIGN ADJUSTABLE DOWNLIGHT

PROJECT INFORMATION

JOB NAME AND INFORMATION

FIXTURE TYPE AND QUANTITY

NOTES
