

# ELEMENT™ 3" HALOGEN

FIXED DOWNLIGHT

Small aperture recessed straight downlight with architectural appearance and optimized lamp positioning. Utilizes the same trims as adjustable 3" new construction housing maintaining a uniform below the ceiling appearance regardless of fixture function. Wood ceiling option allows for a smooth, flangeless appearance using any flangeless trim.

- Flangeless wood ceiling option accommodates variable ceiling thickness
- Accepts 2 optical controls and an optional trim mounted lens
- Compatible with LED MR16 replacement lamp. LED MR16 requires no load electronic transformer (12 watt max).
- Power supplies can be accessed through the aperture
- Glare reducing snoot integrated
- Lensed and shower options include Solite™ soft focus lens at aperture

## Installation

- Includes adjustable hanger bars. Includes butterfly brackets that attach to the side of the housing and are vertically adjustable with a wing nut.
- Incorporates integral gunsights for positioning with laser level or string

## SPECIFICATIONS

LAMP	Low-voltage MR16 lamp assemblies per housing. Compatible with LED MR16 replacement lamps.
WATTS (MAX.)	Halogen: 75w Non-IC, 50w IC
VOLTAGE	120V or 277V
DIMMING*	ELV or MLV (Dimming dependent on transformer type).
CEILING APPEARANCE	Flanged (Accommodates up to 2.5" drywall ceiling thickness, depending on trim) or Flangeless
CEILING APERTURE	3-7/8"
HOUSING	IC Airtight, Non-IC, Chicago Plenum, IC suitable up to R60 spray foam insulation
POWER SUPPLY	Halogen: Electronic or Magnetic transformer. No load transformer required for LED MR16 compatibility (12 watt max in IC).
GENERAL LISTING	ETL listed. Damp listed. Shower version wet listed.
CONSTRUCTION	Housing: Heavy gauge cold rolled steel Trims: Die-cast aluminum
FINISH	Housing: Black Trims: Antique Bronze, Black, Satin Nickel, White (paintable)
WARRANTY**	1 year

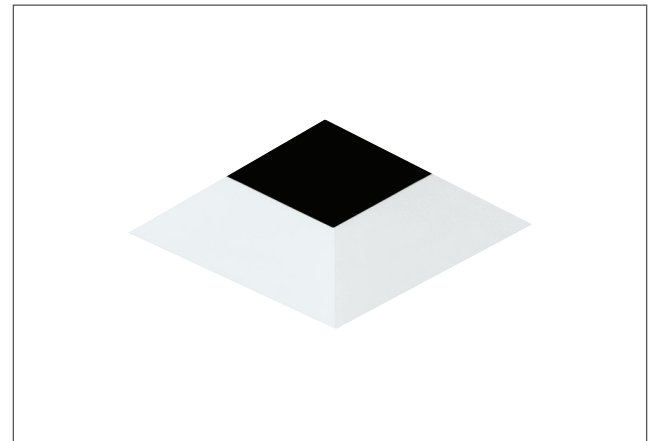

shown in flangeless bevel square

\*See ELEMENT-lighting.com for dimmer compatibility.  
\*\*Visit ELEMENT-lighting.com for specific warranty limitations and details.

# ELEMENT™ 3" HALOGEN

FIXED DOWNLIGHT

## GRIDS

## HOUSING

PRODUCT SERIES	CEILING APPEARANCE	LAMP	FUNCTION	HOUSING RATING	TRANSFORMER	WATTAGE RESTRICTION	VOLTAGE
<b>E3R</b> ELEMENT 3" ROUND	<b>LF</b> FLANGELESS	<b>-H</b> HALOGEN MR16	<b>D</b> DOWN	<b>I</b> IC AIRTIGHT	<b>E</b> ELECTRONIC***	NONE (LEAVE BLANK)	120 VOLT (LEAVE BLANK)
<b>E3S</b> ELEMENT 3" SQUARE	<b>FF</b> FLANGED	<b>WC</b> WOOD CEILING**		<b>N</b> NON-IC AIRTIGHT	<b>M</b> MAGNETIC	<b>-WR</b> WATTAGE RESTRICTION*	<b>-277</b> 277 VOLT
				<b>C</b> CHICAGO PLENUM	<b>R</b> REMOTE		
				IC NOT AVAILABLE WITH ELECTRONIC TRANSFORMER	<b>N</b> NO LOAD ELECTRONIC‡		

TRIMS ARE REQUIRED AND MUST BE ORDERED SEPARATELY.

\*TO INCLUDE WATTAGE RESTRICTION LABEL, SPECIFY -WR AT THE END OF THE HOUSING ITEM NUMBER AND SPECIFY WATTAGE (EXAMPLE: -WR37).

\*\*WOOD CEILING OPTION ACCOMMODATES FLANGELESS TRIMS ONLY. ROUND NOT AVAILABLE WITH MAGNETIC TRANSFORMER.

\*\*\*STANDARD ELECTRONIC NOT AVAILABLE IN IC.

‡NO LOAD ELECTRONIC SUITABLE FOR IC WITH MAX 12 WATT LED MR16 REPLACEMENT LAMP.

## TRIM

PRODUCT SERIES	CEILING APPEARANCE	TRIM STYLE	APERTURE	FINISH
<b>E3R</b> ELEMENT 3" ROUND	<b>L</b> FLANGELESS UP TO 1" CEILING THICKNESS	<b>B</b> BEVEL	<b>-O</b> NO LENS	<b>Z</b> ANTIQUE BRONZE
<b>E3S</b> ELEMENT 3" SQUARE	<b>F</b> FLANGED UP TO 1" CEILING THICKNESS	<b>F</b> FLAT	<b>-H</b> SHOWER	<b>B</b> BLACK
	<b>F15</b> FLANGED 1.1"-1.5" CEILING THICKNESS		<b>-L</b> LENSED	<b>S</b> SATIN NICKEL
	<b>F20</b> FLANGED 1.6"-2.0" CEILING THICKNESS			<b>W</b> WHITE
	<b>F25</b> FLANGED 2.1"-2.5" CEILING THICKNESS			

WOOD CEILING OPTION ACCOMMODATES FLANGELESS TRIMS ONLY.

## PROJECT INFO

FIXTURE TYPE & QUANTITY	JOB NAME & INFO	NOTES

 **TECH LIGHTING**

VISUAL COMFORT & CO.

7400 Linder Avenue, Skokie, Illinois 60077

T 847.410.4400 F 847.410.4500



© 2020 Tech Lighting, L.L.C. All rights reserved. The "Tech Lighting" graphic is a registered trademark. Tech Lighting reserves the right to change specifications for product improvements without notification.

## TRIMS

### ROUND

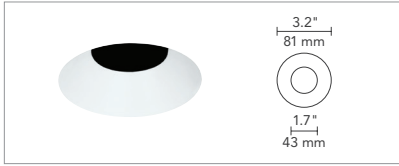

FLANGELESS BEVEL

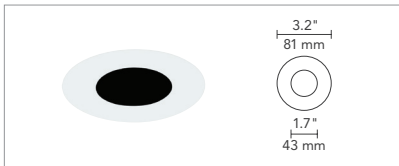

FLANGELESS FLAT

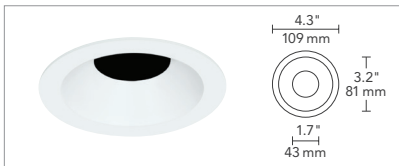

FLANGED BEVEL

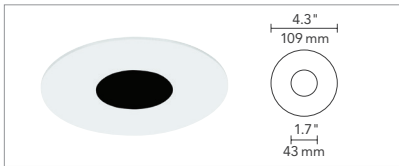

FLANGED FLAT

### SQUARE

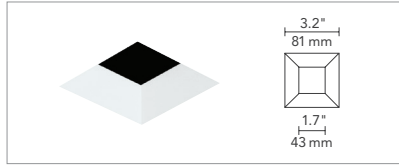

FLANGELESS BEVEL

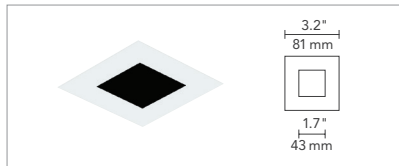

FLANGELESS FLAT

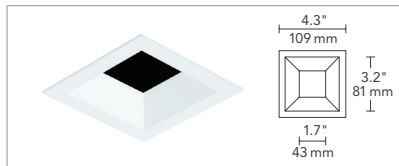

FLANGED BEVEL

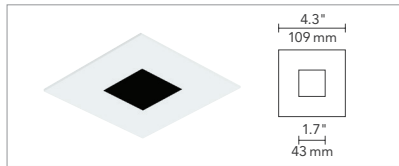

FLANGED FLAT

### FINISH

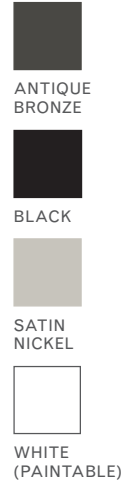

## 3" HOUSING

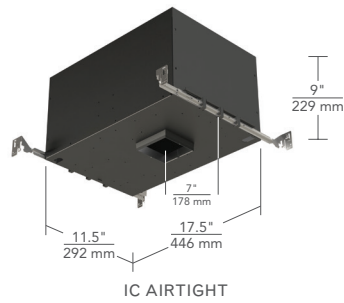
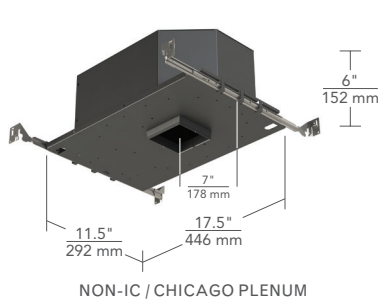

## WOOD CEILING OPTIONS / FLANGELESS TRIMS

### ROUND



FLANGELESS BEVEL (ANTIQUE BRONZE)



FLANGELESS FLAT (ANTIQUE BRONZE)



FLANGELESS BEVEL (SATIN NICKEL)

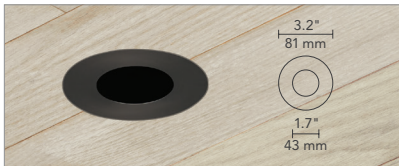

FLANGELESS FLAT (SATIN NICKEL)

### SQUARE

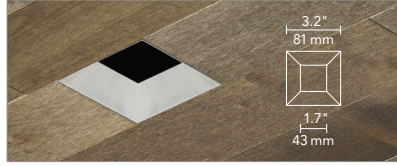

FLANGELESS BEVEL (ANTIQUE BRONZE)



FLANGELESS FLAT (ANTIQUE BRONZE)

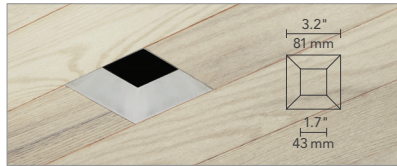

FLANGELESS BEVEL (SATIN NICKEL)

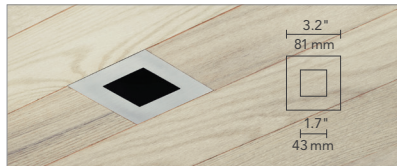

FLANGELESS FLAT (SATIN NICKEL)

### FINISH

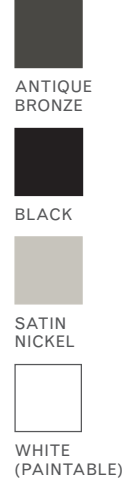

## ADJUSTABLE TRIM ADAPTER

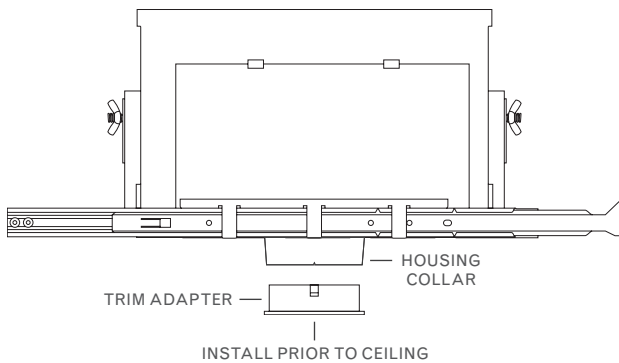

### TRIM ADAPTER INSTALLED

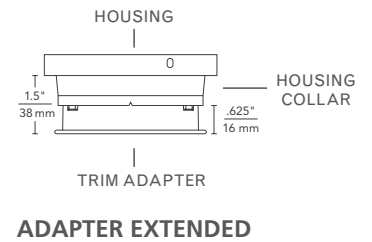
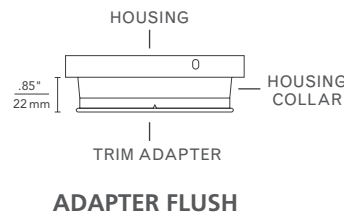

Wood ceiling housings (“WC” designation in the ordering grid) ship with an adjustable trim adapter that inserts into the housing aperture and allows standard ELEMENT 3” flangeless trims to achieve a truly flangeless, flush ceiling appearance in special applications such as wood or stone installation. For use in new construction.

**Consult installation instructions regarding plenum requirements and ceiling thickness ratios.**