

ELEMENT™ 2" LED

ADJUSTABLE DOWNLIGHT & WALL WASH



SHOWN IN FLANGELESS BEVEL SQUARE

The ELEMENT 2" Adjustable Downlight is your solution for an aesthetically minimal recessed fixture featuring a quiet ceiling and high lumen output. The Adjustable Downlight delivers on performance and adjustability including lockable and tool-free hot aiming. ELEMENT's patented high/low lamp positioning allows the LED to be positioned closer or further from the 1.4" aperture for maximum light output or to minimize glare. Complementing ELEMENT 3" and 4" fixtures, the 2" Adjustable Downlight and Wall Wash platforms offer wood ceiling installation and a convenient Remodel option with the same performance and trim options.

- 1-step static white, 2-step warm dim and tunable white
- Lensed and shower aperture includes Solite soft focus lens
- Lockable tool-free aiming, 0-45° tilt, 361° rotation, and high/low lamp positioning (patent protected)
- Interchangeable optics: 20°, 30°, 40°, 60°, or wall wash trim options
- Wood ceiling and remodel installation available

LUMEN MULTIPLIER (CRI/CCT)

CCT	80 CRI MULTIPLIER	90 CRI MULTIPLIER
2700K	0.95	0.80
3000K	1.00	0.85
3500K	1.05	0.90

Lumen output will vary by CCT and CRI.
See photometric charts for output information.

SPECIFICATIONS

	STATIC WHITE				WARM DIM	TUNABLE WHITE	
	HIGH OUTPUT		LOW OUTPUT		LOW OUTPUT	HIGH OUTPUT (5000K)	HIGH OUTPUT (4000K)
DELIVERED LUMENS	1500	1250	1163	930	850	919	830
WATTS	17	17	12	12	12	16	16
EFFICACY	88	73	97	77	71	57	52
CRI	80+	90+	80+	90+	90+	90+	
CBCP	20° - 5,136 30° - 4,644 40° - 3,050 60° - 1,764						
CCT	2700K, 3000K, or 3500K				3000K - 1800K	5000K - 2700K	4000K - 1800K
COLOR CONSISTENCY	1-step				2-step	2-step	
VOLTAGE	120V or 277V						
DIMMING ¹	Standard reverse-phase, forward-phase, TRIAC, and 0-10V dimming down to 1% eldoLED 0-10V or DALI-2 down to 0.1% Lutron Hi-lume EcoSystem down to 0.1%					eldoLED 0-10V or DALI-2 down to 0.1%	
POWER SUPPLY	Constant current driver with +.9 power factor and +80% efficiency						
OPTICS	20°, 30°, 40°, 60°, or wall wash						
ADJUSTABILITY	0-45° tilt, high/low positioning. Round housing has 361° rotation. Square housing has 90° rotation increments. 45° alignment for square collar.						
CEILING APPEARANCE	Flanged, flangeless, flangeless in wood ceiling						
CEILING MOUNT CEILING THICKNESS	Flanged, flangeless: 3/8" to 2" Flangeless in wood ceiling: 1/2" to 2" Note: Tilt restricted in thicker ceilings. Not for use with T-grid (acoustic tile)						
HOUSING MOUNT CEILING THICKNESS	T-grid/flanged: Up to 1"						
CEILING APERTURE	2-3/4" ceiling cutout						
HOUSING	IC Airtight, Chicago Plenum. IC suitable up to R60 spray foam insulation. Sauna/steam-room use available only with combination of H shower trim, LO low output housing, and I IC housing rating.						
CONSTRUCTION	Housing: Heavy-gauge, cold-rolled steel Trim: Die-cast aluminum						
FINISH	Housing: Black powder coat Trim: Antique Bronze, Black, Satin Nickel, or White (paintable)						
GENERAL LISTINGS	ETL Listed. Damp Location. Shower version Wet Listed.						
CALIFORNIA TITLE 24	Registered CEC appliance database. Complies with CEC 2019 Title 24 Part 6 (JA8-2016, JA8-2019) (for 90 CRI versions).						
L70	50,000 hours min						
WARRANTY ²	5 years						

Data in chart reflect 3000K/80 CRI values unless noted.
Custom output/custom RAL/custom CCT available, contact Quotes Department.

Ordering grids available on page 2.

¹See visualcomfort.com for dimmer compatibility.

²Visit visualcomfort.com for specific warranty limitations and details.

ELEMENT™ 2" LED

ADJUSTABLE DOWNLIGHT & WALL WASH

ORDERING GRIDS

HOUSING

PRODUCT	CEILING APPEARANCE	LAMP	CRI/CCT	BEAM SPREAD	FUNCTION	HOUSING RATING	DRIVER
E2R ELEMENT 2" ROUND	L FLANGELESS (CEILING MOUNT) ¹	-LH HIGH OUTPUT, 17W ⁴ -LO LOW OUTPUT, 12W ⁵	827 80 CRI, 2700K, 1-STEP 830 80 CRI, 3000K, 1-STEP	20 20° 30 30°	A ADJUSTABLE ⁸	I IC AIRTIGHT C CHICAGO PLENUM	INTEGRATED DRIVERS 120V/277V UNIVERSAL PHASE/0-10V 1% (LEAVE BLANK) ⁹
E2S ELEMENT 2" SQUARE	F FLANGED (CEILING MOUNT) ¹ WC WOOD CEILING (CEILING MOUNT) ^{1,2} T T-GRID/FLANGED (HOUSING MOUNT) ³		835 80 CRI, 3500K, 1-STEP 927 90 CRI, 2700K, 1-STEP 930 90 CRI, 3000K, 1-STEP 935 90 CRI, 3500K, 1-STEP 9WD 90 CRI, 3000K-1800K, WARM DIM, 2-STEP ⁶ 9TW52 90 CRI, 5000K-2700K, TUNABLE WHITE, 2-STEP ⁷ 9TW41 90 CRI, 4000K-1800K, TUNABLE WHITE, 2-STEP ⁷	40 40° 60 60°			REMOTE DRIVERS 120V/277V¹⁰ -ELDO ELDOLED 0.1% 0-10V LINEAR -ELDOA ELDOLED 0.1% 0-10V LOGARITHMIC -ELDD ELDOLED 0.1% DALI-2 -ELTO ELDOLED TUNABLE WHITE 0.1% 0-10V LINEAR ⁷ -ELTD ELDOLED TUNABLE WHITE 0.1% DALI-2 ⁷ -HLECO LUTRON HI-LUME 0.1% ECOSYSTEM

A

Trims are required and must be ordered separately.

For dimming details, refer to dimmer compatibility chart.

¹L, F, WC - For max 2" ceiling thickness, mechanism and collar are field assembled to the ceiling, per instructions.

²WC - Wood ceiling accommodates flangeless trims only.

³T - For max 1" ceiling thickness, mechanism and collar are factory assembled to the housing; trim extender collar is required for ceiling thicknesses greater than 0.500".

⁴LH - High output available for Wet Rated. Not rated for sauna/steam-room.

⁵LO - Sauna/steam-room use available only with combination of H shower trim, LO low output housing, and I IC housing rating.

⁶9WD - Only available low output.

⁷9TW52/9TW41 - Tunable white only available in high output, only available with ELTO (0-10V, linear), or ELTD (DALI-2). For 0-10V logarithmic dimming consult Quotes Department.

⁸A - Adjust to 15° tilt for wall wash application, 30° beam spread optimal.

⁹Universal dimming is reverse-phase, forward-phase, TRIAC, and 0-10V dimming. 277V is only compatible with 0-10V dimming.

¹⁰Remote driver ships with 4" x 8" x 1.8" black enclosure for remote location mounting.

TRIM

PRODUCT	CEILING APPEARANCE	STYLE	APERTURE	FINISH
E2R ELEMENT 2" ROUND	L FLANGELESS ¹	B BEVEL	-O NO LENS	Z ANTIQUE BRONZE
E2S ELEMENT 2" SQUARE	F FLANGED ² F6 FLANGED TRIM EXTENDER, 0.500" - 0.625" CEILING THICKNESS ³ F7 FLANGED TRIM EXTENDER, 0.625" - 0.750" CEILING THICKNESS ³ F8 FLANGED TRIM EXTENDER, 0.750" - 0.875" CEILING THICKNESS ³ F1 FLANGED TRIM EXTENDER, 0.875" - 1.000" CEILING THICKNESS ³	F FLAT W WALL WASH ⁴	-H SHOWERS ^{5,6} -L LENSED ⁶ -W WALL WASH (LENSED) ⁴	B BLACK S SATIN NICKEL W WHITE (PAINTABLE)

¹L - For use with L flangeless or WC wood ceiling housing option.

²F - If used with T-grid/flanged (T) style housing, flanged trims work for 0.500" ceiling thickness without trim extenders.

³F6/F7/F8/F1 - For use with T-grid/flanged (T) style housing and ceiling thickness greater than 0.500".

⁴W - Wall wash style trim (W) requires wall wash lensed aperture (W).

⁵H - Sauna/steam-room use available only with combination of H shower trim, LO low output housing, and I IC housing rating. Shower lens includes a gasket.

⁶H, L - Lensed products come with Solite Soft Focus lens.

LENSES/LOUVERS¹

PRODUCT	TYPE
MOC	GG PLAIN GLASS SF SOFT FOCUS LL LINEAR SPREAD EC EGGCRATE LOUVER LS1 1" LONG SNOOT LS12 1/2" LONG SNOOT

MOC

¹Lenses/louvers mounted to lamp assembly only (max 2).

REPLACEMENT OPTICS

PRODUCT	BEAM SPREAD
353LEDGATOPT	20 20° 30 30° 40 40° 60 60°

353LEDGATOPT

APERTURE SHIELD FOR CEILING THICKER THAN 1"

PRODUCT	CEILING APPEARANCE	FINISH
E2R ELEMENT 2" ROUND E2S ELEMENT 2" SQUARE	AC APERTURE COLLAR FOR UP TO 2" THICK CEILINGS	B BLACK

AC

B

PLASTER PLATES

PRODUCT	
150E2RCL	2" PLASTER PLATE ROUND SHEET METAL
150E2SCL-A	2" PLASTER PLATE SQUARE SHEET METAL

Plaster plates are used to convert flanged housings into flangeless housings. Ships standard with flangeless housings.



ELEMENT™ 2" LED

ADJUSTABLE DOWNLIGHT & WALL WASH

TRIMS

FLANGED

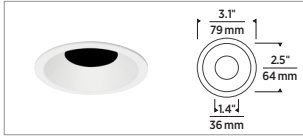

ROUND BEVEL

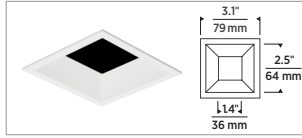

SQUARE BEVEL

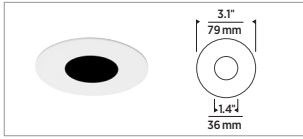

ROUND FLAT

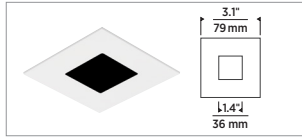

SQUARE FLAT

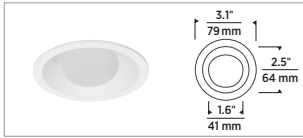

ROUND WALL WASH

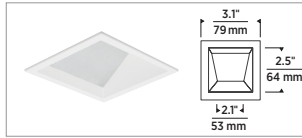

SQUARE WALL WASH

FLANGELESS



ROUND BEVEL

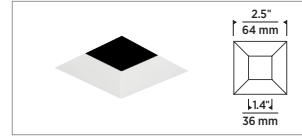

SQUARE BEVEL

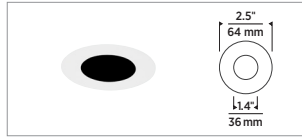

ROUND FLAT

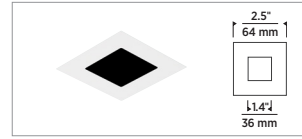

SQUARE FLAT

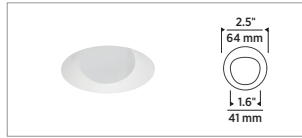

ROUND WALL WASH

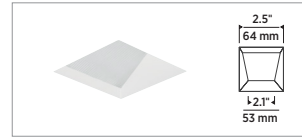

SQUARE WALL WASH

FINISH



ANTIQUE BRONZE



BLACK



SATIN NICKEL



WHITE (PAINTABLE)

FLANGELESS IN WOOD CEILING

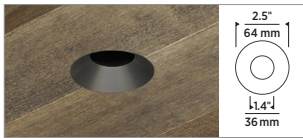

ROUND BEVEL (ANTIQUE BRONZE)

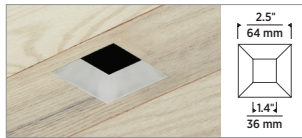

SQUARE BEVEL (SATIN NICKEL)



ROUND FLAT (ANTIQUE BRONZE)

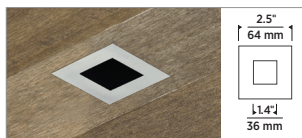

SQUARE FLAT (SATIN NICKEL)



ROUND FLAT (ANTIQUE BRONZE)



SQUARE FLAT (SATIN NICKEL)

LENS OPTION



SHOWN WITH AND WITHOUT A LENS (SQUARE FLANGED BEVEL)



SHOWN WITH AND WITHOUT A LENS (ROUND FLANGELESS BEVEL)

ELEMENT™ 2" LED

ADJUSTABLE DOWNLIGHT & WALL WASH

WARM DIM CURVE

CCT vs. Forward Current, $T_c=25^\circ\text{C}$

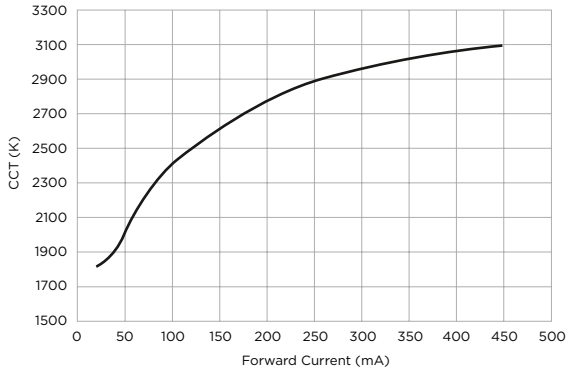

HOUSING

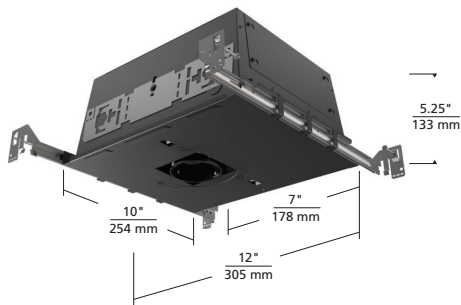

IC AIRTIGHT/ CHICAGO PLENUM
 FLANGED/ WOOD CEILING/ FLANGELESS CEILING MOUNT

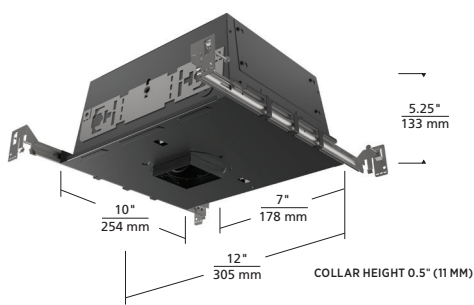

IC AIRTIGHT/ CHICAGO PLENUM
 T-GRID/ FLANGED HOUSING MOUNT

MUD/PLASTER PLATES

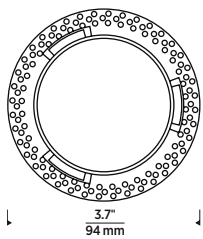

ROUND SHEET METAL
 MUD/PLASTER PLATE IS
 INCLUDED FOR FLANGELESS
 INSTALLATION

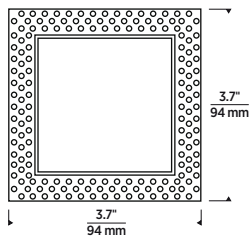

SQUARE SHEET METAL
 MUD/PLASTER PLATE IS
 INCLUDED FOR FLANGELESS
 INSTALLATION

ELEMENT™ 2" LED

ADJUSTABLE DOWNLIGHT & WALL WASH

FLANGED/FLANGELESS/WOOD CEILING - CEILING MOUNTED COLLAR

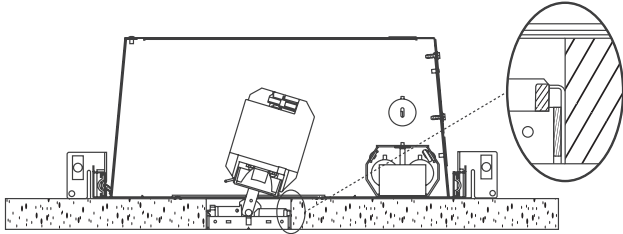

Ceiling Mounted Collar

- Flanged, flangeless or flangeless in wood ceiling (see instructions)
- Compatible with drywall, wood
- Not compatible with T-Grid (Acoustic Tile)
- Optimizes lamp position regardless of ceiling thickness
- Allows install in up to 2" ceiling thickness

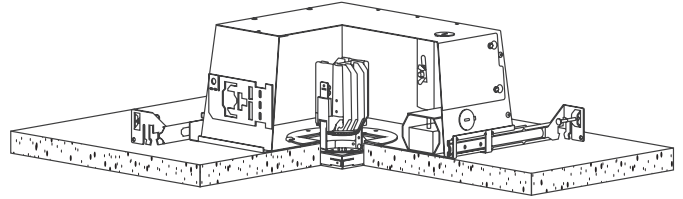

T-GRID/FLANGED - HOUSING MOUNTED COLLAR

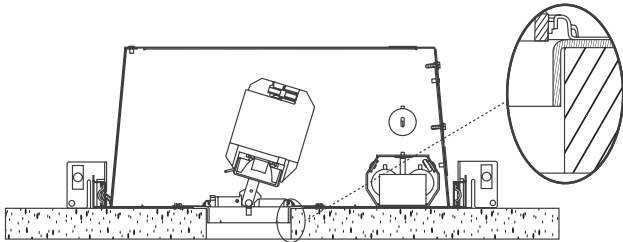

Housing Mounted Collar

- Flanged only
- Compatible with T-Grid (Acoustic Tile), drywall, wood
- For 1" ceiling thickness max

When ordering the T-Grid/Flanged with Housing Mounted Collar, please order trim extender for ceiling thicknesses greater than 0.5" and for use up to 1" thickness (max). **Please consult instruction sheet.**

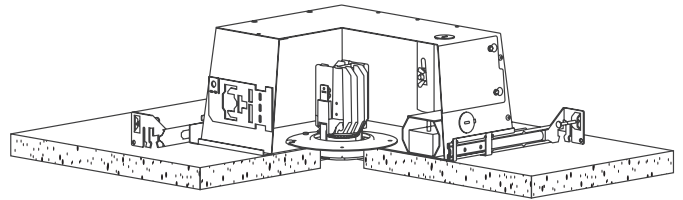

FLANGELESS IN WOOD CEILING INSTALLATION

IMPORTANT:
READ INSTALLATION INSTRUCTIONS
THOROUGHLY PRIOR TO INSTALL

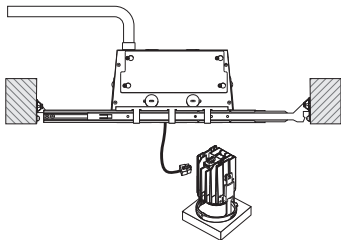

PLACE LIGHT MODULE INTO HOUSING
BEFORE CEILING ASSEMBLY

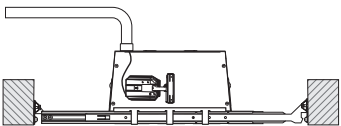

PREPARE WOOD CEILING

Use a 2-9/16" hole saw (round) or mill a 2.57" square opening in the wood. The wood must be at least 1/2" thick for the trims to hold firmly in place.

Use a 1/4" rabbet router bit to create a larger opening on the top side of the wood. The rabbet must cut to a depth that leaves 3/16" of wood above the ceiling level.

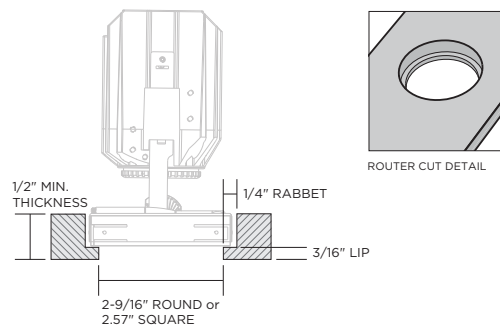

INSERT TRIM INTO THE COLLAR

Align the trim with the inner edge of the collar. Push the trim into the collar so that it snaps into place.

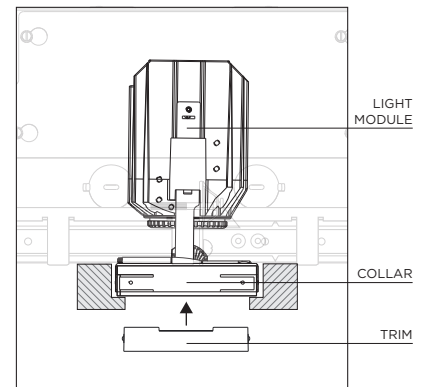

ELEMENT™ 2" LED

ADJUSTABLE DOWNLIGHT & WALL WASH

ELEMENT Specular Reflectors reduce glare while creating a clean, quiet ceiling appearance. These beautiful trim accessories have been specifically designed to minimize any effect on light performance, color and output. Specular Reflectors are available for both Adjustable and Fixed downlights and are compatible with ELEMENT 2" trims and housings.

- Can be easily installed or removed
- Assembles to existing ELEMENT 2" trim
- Compatible with fixed and adjustable housings

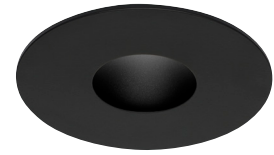

BELOW CEILING VIEW



SHOWN MOUNTED TO TRIM



REFLECTOR ONLY

COMPATIBLE TRIMS	NON-SLOTTED (FOR FIXED ¹)	SLOTTED (FOR ADJUSTABLE)
2" round, flanged, bevel	E2TREFNS3B	E2TREFS4B
2" round, flanged, flat	E2TREFNS2B	E2TREFS3B
2" round, flangeless, bevel	E2TREFNS3B	E2TREFS4B
2" round, flangeless, flat	E2TREFNS2B	E2TREFS3B
2" square, flangeless, bevel	E2TREFNS1B	E2TREFS2B
2" square, flanged, bevel	E2TREFNS1B²	E2TREFS2B²

Only compatible with ELEMENT 2" LED series.
May require lamp to be placed in high position.
Not available for ELEMENT 2" square flat trims.
Not compatible with lensed trims.

¹Non-slotted reflectors may be used in adjustable housings with the lamp assembly placed in the 0° tilt position.

²Not compatible with flanged trim extenders F6, F7, F8, F1.

ORDERING GRIDS

E2 TRIM MOUNTED REFLECTORS¹

PRODUCT	STYLE	FINISH
E2TREF	NS1 NON-SLOTTED	B ANODIZED BLACK
	NS2 NON-SLOTTED	
	NS3 NON-SLOTTED	
	S2 SLOTTED	
	S3 SLOTTED	
	S4 SLOTTED	

E2TREF **B**

¹Not compatible with lensed trims. Reflectors are placed on top of the inside of the trim or affixed via screws (only if provided).

ELEMENT™ 2" LED

ADJUSTABLE DOWNLIGHT & WALL WASH

PHOTOMETRICS

Description: 2" LED Module
20° Beam - 0° Tilt, 3000K

Model: E2 Adjustable
20° High Output

Input Power (Watts): 18.7
Input Power Factor: 0.98

Absolute Luminous Flux (Lumens): 1206
Lumen Efficacy (Lumens per Watt): 64.5

Description: 2" LED Module
30° Beam - 0° Tilt, 3000K

Model: E2 Adjustable
30° High Output

Input Power (Watts): 18.7
Input Power Factor: 0.98

Absolute Luminous Flux (Lumens): 1414
Lumen Efficacy (Lumens per Watt): 75.5

Description: 2" LED Module
40° Beam - 0° Tilt, 3000K

Model: E2 Adjustable
40° High Output

Input Power (Watts): 18.7
Input Power Factor: 0.98

Absolute Luminous Flux (Lumens): 1565
Lumen Efficacy (Lumens per Watt): 83.7

Output difference between CCTs - 5%, CRIs - 15%.

ANGLE	0°	45°	90°
0°	5136	5136	5136
5°	4054	4347	4616
10°	2654	2956	3278
15°	1383	1756	1896
20°	627	878	924
25°	249	326	393
30°	81	128	151
35°	24	65	50
40°	6	30	12
45°	3	6	4
50°	1	2	2
55°	1	1	1
60°	0	1	0
65°	0	1	0
70°	0	1	0
75°	0	1	0
80°	0	0	0
85°	0	0	0
90°	0	0	0

ANGLE	0°	45°	90°
0°	4644	4644	4644
5°	4184	4322	4434
10°	3249	3454	3698
15°	1948	2286	2488
20°	933	1178	1304
25°	342	428	544
30°	87	161	176
35°	27	68	52
40°	7	27	12
45°	2	5	4
50°	1	2	1
55°	0	1	0
60°	0	1	0
65°	0	1	0
70°	0	0	0
75°	0	0	0
80°	0	0	0
85°	0	0	0
90°	0	0	0

ANGLE	0°	45°	90°
0°	3050	3050	3050
5°	2774	2892	2971
10°	2436	2549	2701
15°	1847	2085	2260
20°	1188	1460	1594
25°	571	776	959
30°	216	353	411
35°	84	142	154
40°	30	53	55
45°	11	18	20
50°	1	7	4
55°	0	2	0
60°	0	0	0
65°	0	0	0
70°	0	0	0
75°	0	0	0
80°	0	0	0
85°	0	0	0
90°	0	0	0

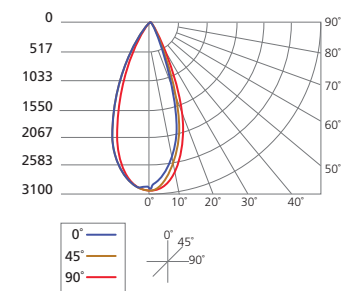
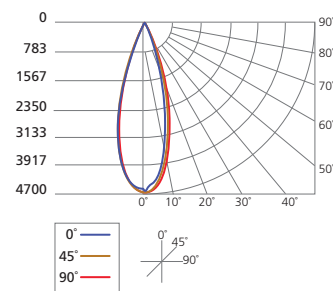
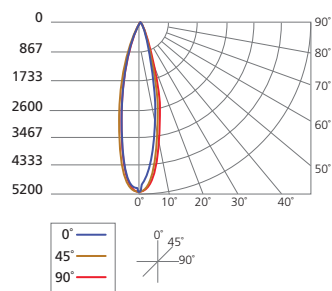
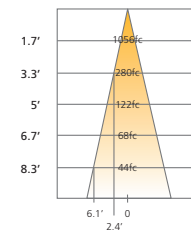
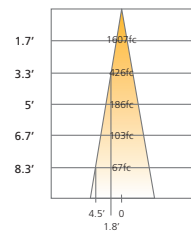
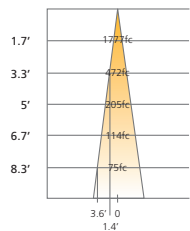

ELEMENT™ 2" LED

ADJUSTABLE DOWNLIGHT & WALL WASH

PHOTOMETRICS

Description: 2" LED Module
 60° Beam - 0° Tilt, 3000K

Model: E2 Adjustable
 60° High Output

Input Power (Watts): 18.7
 Input Power Factor: 0.98

Absolute Luminous Flux (Lumens): 1382
 Lumen Efficacy (Lumens per Watt): 73.7

Output difference between CCTs - 5%, CRIs - 15%.

ANGLE	0°	45°	90°
0°	1764	1764	1764
5°	1667	1724	1721
10°	1562	1612	1629
15°	1380	1445	1483
20°	1109	1233	1235
25°	718	921	923
30°	442	638	542
35°	310	377	350
40°	208	239	238
45°	83	142	139
50°	1	70	26
55°	1	6	1
60°	0	1	0
65°	0	0	0
70°	0	1	0
75°	0	0	0
80°	0	0	0
85°	0	0	0
90°	0	0	0

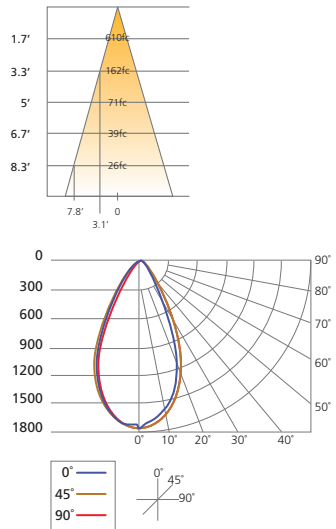

ELEMENT™ 2" LED

ADJUSTABLE DOWNLIGHT & WALL WASH

PROJECT INFORMATION

JOB NAME AND INFORMATION

FIXTURE TYPE AND QUANTITY

NOTES

